

1

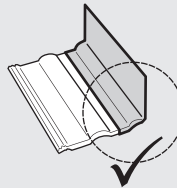

W	[mm]		
	w <sub>1</sub>	w <sub>2</sub>	w <sub>3</sub>
200	120	80	-
250	120	130	-
300	130	170	-
450	170	280	-
600	170	200	230

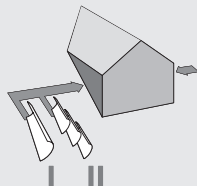
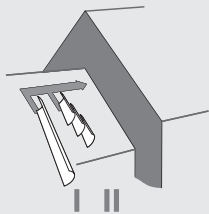
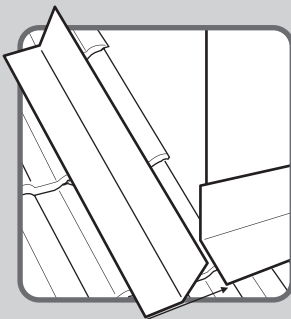
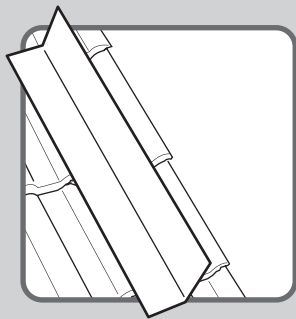
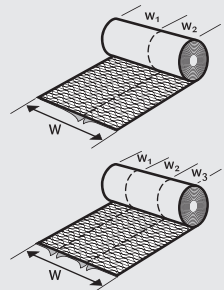

!  $a > c$

	a	b
$\alpha \geq 22^\circ$	$\geq 120 \text{ mm}$	$\geq 80 \text{ mm}$
$\alpha < 22^\circ$	$\geq 120 \text{ mm}$	$\geq 100 \text{ mm}$
$\alpha \geq 10^\circ$	$\geq 120 \text{ mm}$	$\geq 150 \text{ mm}$

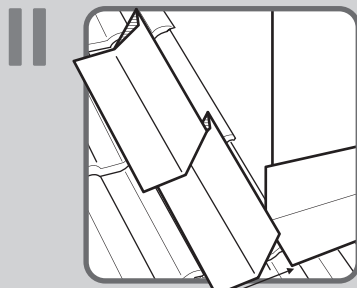
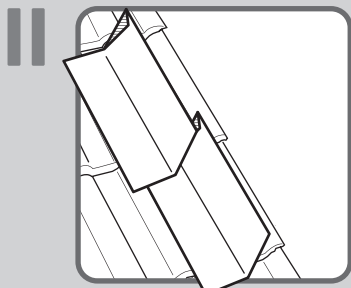

!  $a > c$

	a	b
$\alpha \geq 22^\circ$	$\geq 80 \text{ mm}$	$\geq 80 \text{ mm}$
$\alpha < 22^\circ$	$\geq 80 \text{ mm}$	$\geq 100 \text{ mm}$
$\alpha \geq 5^\circ$	$\geq 80 \text{ mm}$	$\geq 150 \text{ mm}$

2

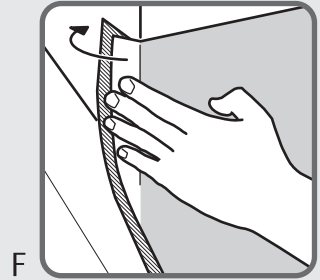
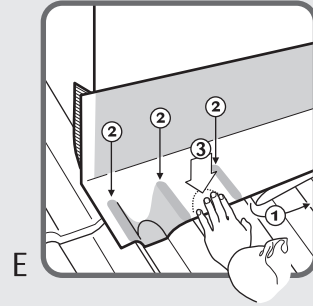
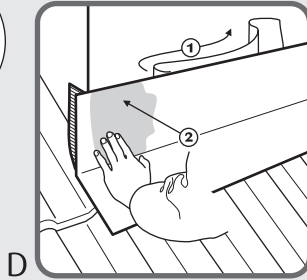
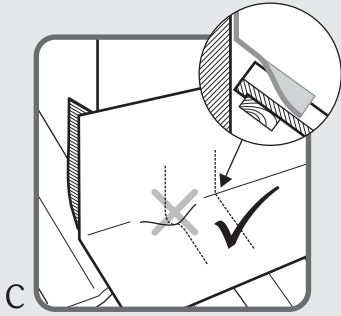
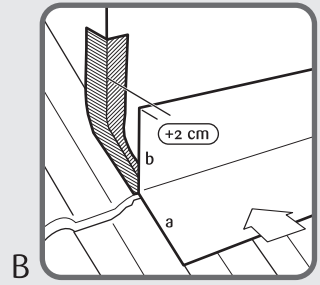
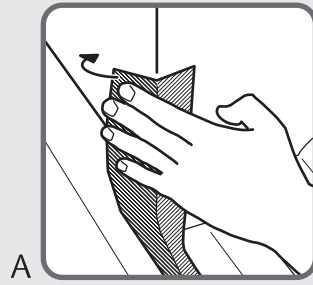
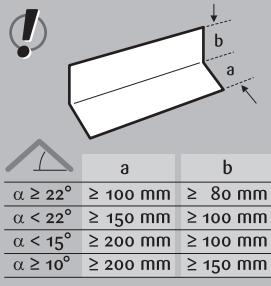
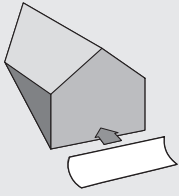

3

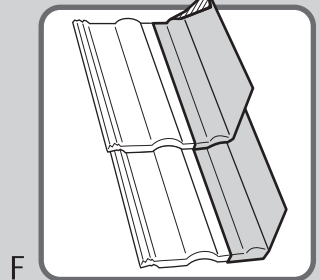
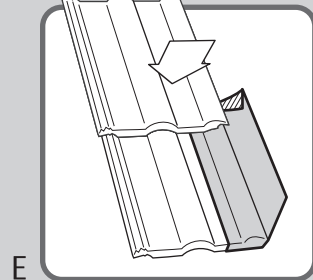
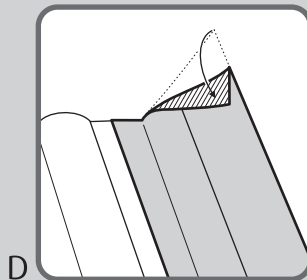
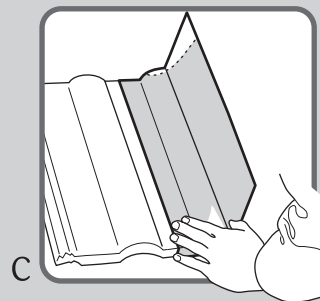
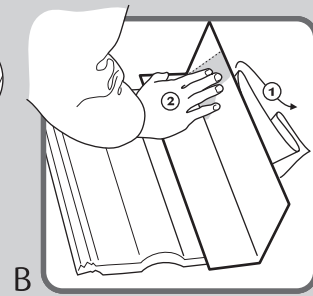
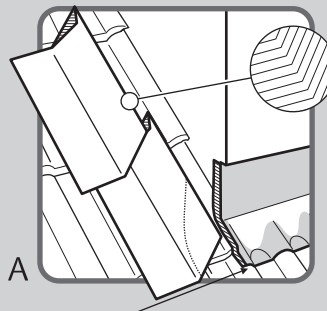
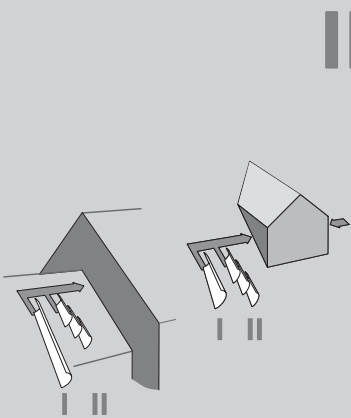
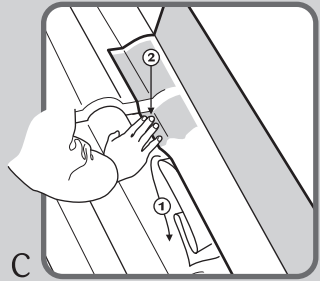
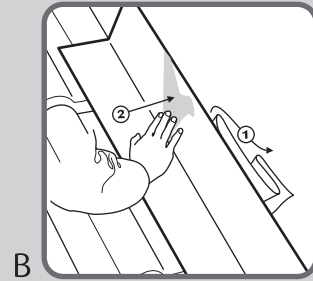
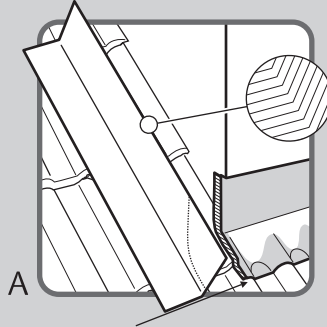
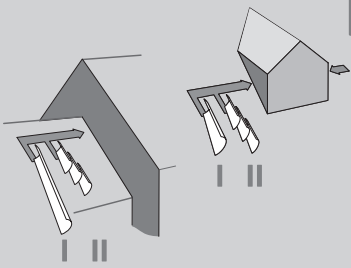

4

